INSTRUCTIONS IMPORTANT SAFEGUARDS

When using electrical equipment, basic safety precautions should always be followed including the following:

1. **READ AND FOLLOW ALL SAFETY INSTRUCTIONS**
2. Disconnect power before performing work on electrical equipment
3. Do not use outdoors
4. Do not let power cords touch hot surfaces and do not mount near gas or electric heaters.
5. Use caution when servicing batteries. Battery acid can cause burns to skin and eyes. If acid is spilled on skin or eyes, flush with fresh water and contact a physician immediately.
6. Equipment should be mounted in locations and at heights where unauthorized personnel will not readily subject it to tampering.
7. The use of accessory equipment not recommended by Mule Lighting, may cause an unsafe condition, and will void the unit's warranty.
8. Do not use this equipment for other than its intended purpose.
9. Servicing of this equipment should be performed by qualified service personnel.
10. **SAVE THESE INSTRUCTIONS!**

INSTALLATION

Hardwired Installation - Recessed Mount For Suspended / T-Bar Ceilings:

1. Extend unswitched 24 hour AC supply of rated voltage to an electrical junction box (supplied by others) installed in accordance with all applicable codes and standards. Extend wiring from the junction box to the location where the unit will be installed. Leave at least 8 inches of slack wire at the end of the circuit. This circuit should NOT be energized/live at this time.
2. Open the unit by unscrewing the cover screws on the top of the unit (Figure 2). The cover side plate can then be lifted up and removed.
3. Unit is supplied with electrical conduit knockouts stamped into the sides of the cabinet. Knock out the appropriate hole(s) and bring wires through the hole(s) into the cabinet. Attach the circuit wires to the cabinet with an approved connector (not supplied).
4. Mount the unit securely into place. Do not rely on the suspended ceiling channel/grid (T-bar) as the only support for the unit. There are two chain mounting holes provided on either side of the top of the unit. Chain or mounting wire should be secured through these holes and then to a secure mounting above the suspended ceiling (Figure 4)
5. Make proper wiring connections between the AC supply and the unit's transformer per diagram provided (Figure 5). Insulate unused wire! Connect ground to supplied green ground wire in accordance with local codes. Reassemble all wire connections and connectors.
CAUTION! - Failure to insulate unused wire may result in a shock hazard or unsafe condition as well as equipment failure.
6. For large units the batteries may be shipped separately. Install batteries into the cabinet and complete the appropriate battery connections (Figure 6).
7. Uncoil the wire lead(s) from the Positive circuit board terminal (+) and connect to the positive terminal connector on the battery (Figure 3).
8. Route wires and secure in place.
9. Replace cover and secure cover screws.
10. Turn on AC line voltage supply.
11. Position lamps/heads to provide best lighting distribution by loosening head set screws to adjust angle and swivel. Manually rotate or twist head to desired position then tighten set screws to lock position.

CAUTION

This equipment is furnished with a sophisticated low voltage battery dropout circuit to protect the battery from over-discharge after it's useful output has been used. Allow 24 hours recharge time after installation or power failure for full-load testing.

OPERATION

1. To Test, depress the TEST Switch. Charge indicator will go out and the DC lamps will come on.
2. Release the TEST Switch. DC lamps will be extinguished, and the charge indicator will come on.
3. A bright charge indicator indicates a high charge rate. After the battery has reached full charge, the indicator light will go out. Under normal operation the high charge indicator will turn off and on intermittently while the unit is in standby mode (regular/mains AC present) since the charge rate will vary in order to maintain an optimal battery charge.

Figure 1

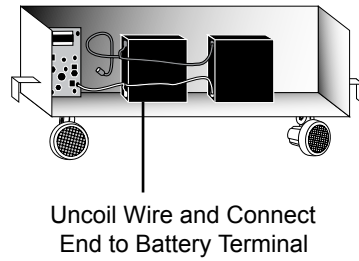
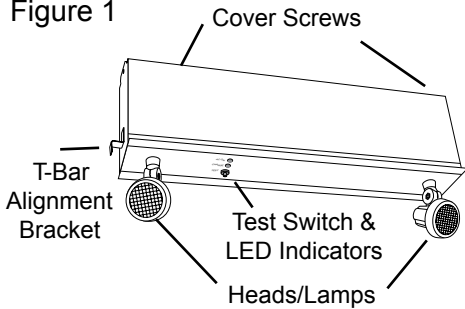
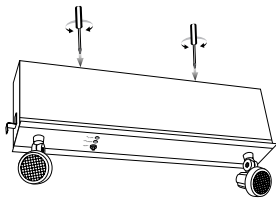

Figure 2

Remove Cover Screws



Lift out Cover Plate

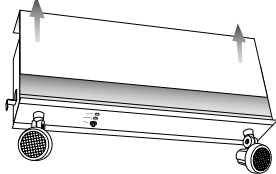

Figure 4

Chains or Wire Attached to Mounting Above

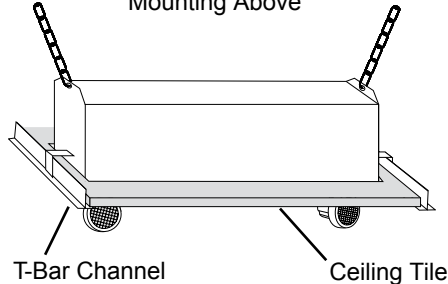

Figure 3

CHARGER BOARD
STANDARD DUAL INPUT VERSION

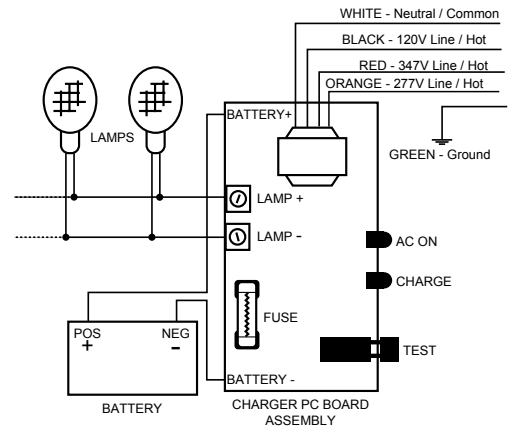
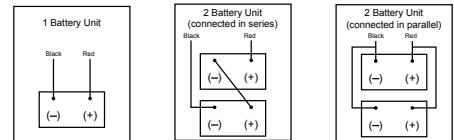

Figure 5



MAINTENANCE

- Code requires that the equipment be tested every 30 days for 30 seconds, and that written records be maintained. Further, the equipment is to be tested once a year for the required duration as per Code. The battery is to be replaced or the equipment repaired whenever the equipment fails to operate as intended during the duration test. Written records of test results and any repairs made must be maintained. Mule Lighting, Inc. strongly recommends compliance with all Code requirements.
- Clean lenses on a regular basis.

NOTE: The servicing of any parts should be performed by qualified service personnel only. The use of replacement parts not furnished by Mule Lighting, Inc., may cause equipment failure and will void the warranty.

TROUBLESHOOTING

EMERGENCY LAMPS DO NOT COME ON AT ALL

Pilot Light is out before test...

- Check AC supply - be sure unit has 24 hour AC supply (unswitched).
- AC supply is OK, and indicator light is out, replace PC Board Assembly.

Pilot Light is on before test...

- Either the output is shorted or overloaded, or the battery is not connected.
- Battery is severely discharged. Allow 24 hours for recharge and then retest. NOTE: This could be the result of a switched AC supply to the unit (which has been turned off at some point), a battery with a shorted cell, an old battery or a battery which has been discharged due to a long power outage and is not yet fully recharged.

EMERGENCY LAMPS COME ON DIM WHEN TEST BUTTON IS PRESSED

- Battery discharged - permit unit to charge for 24 hours and then retest. If lamps are still dim, check charger for proper function. If charger functions correctly, replace battery.

EMERGENCY LAMPS COME ON WHEN BATTERY IS FIRST CONNECTED

- Battery may be connected in reverse polarity. Check connections. Connect Positive lead to Positive battery terminal and Negative lead to Negative battery terminal. The lamps should then turn off and the charge indicator should light when AC power is applied.

EMERGENCY LAMPS COME ON DIM WHEN AC POWER IS ON -

- Check supply voltage and AC connections. This emergency light is provided with brownout protection. The AC supply must be at least 80% of nominal (96V on a 120V line) for equipment to function normally. At lower voltages the emergency lamps will begin to glow dimly until the source voltage drops below the full "turn-on" point. NOTE: This condition may also be caused by incorrectly connecting a 120 Volt supply line to the incorrect voltage transformer lead.

SAVE THESE INSTRUCTIONS