



PATRIOT Series - NEMA 4X

NEMA 4X, VANDAL RESISTANT



PROJECT: _____
 FIXTURE TYPE: _____
 LOCATION: _____
 CONTACT/PHONE: _____



SPECIFICATIONS: INTERNAL

The PATRIOT UNIT has a 120/277V input and designed to perform in applications where the environment would punish any standard unit. The entire internal cavity is protected from moisture ingress by an extremely resilient gasket. The gasketing always holds its original form and has “memory retention” so that it effectively and consistently protects the PATRIOT UNIT from moisture. The standard lead acid battery or optional nickel cadmium battery provides a minimum emergency duration of 90 minutes.

SPECIFICATIONS: EXTERNAL

The PATRIOT UNIT is constructed from 0.100” thick, heavy duty cast aluminum. Stainless steel tamper resistant screws are standard and ensure the integrity of the battery unit. The PATRIOT UNIT comes standard in an industrial gray color although custom color options are available upon request. The PATRIOT UNIT comes standard with an LED status indicator and test switch under the lens.

The lens is constructed from a vandal resistant polycarbonate for maximum durability. Lamp and reflector assemblies are offered in a fully adjustable, high output MR16 halogen or LED configurations. Universal mounting pattern and key hole slots are cast into the backplate. Stainless steel mounting straps are supplied for surface mounting.

DIMENSIONS

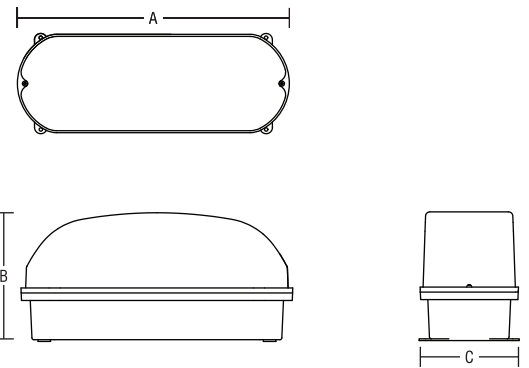

Series	A"	B"	C"
PTR	16.25"	7.5"	6"
	413mm	191mm	152mm

ORDERING INFORMATION

EXAMPLE: PTR-6-36-MR16LED-5W-AT



Series	Operation	Pb-A (Capacity)	Ni-Cd (Capacity)	Lamp Type	Options
PTR	6 (6V)	18 (6V)	22 (6V)	See lamp selection guide on next page	AM* (ammeter)
	12 (12V)	27 (6V, 12V)	42 (6V, 12V)		AT1* (auto-test)
		36 (6V, 12V)			FAI ³ * (fire alarm interface)
		60 (6V, 12V)			IH* (internal heater- specify AC)
				IRT ^{4*} (infrared testing)	
				MT (magnetic test switch)	
				NC ⁵ (nickel-cadmium battery)	
				RC (remote capable)	
				VM* (voltmeter)	
				WG (wireguard)	
				TP (tamper proof)	

NOTE *: Only available in units 60W and under.

NOTE 1: Includes an automatic time delay function specify 0, 5, 10 or 20 mins.

NEMA 4X | WET | IP66 | COLD | VANDAL RESISTANT

NOTE 3: Specify type- open/closed dry contact.

NOTE 4: HHC (controller for IRT) should be ordered separately.

NOTE 5: NC (select wattage/voltage from Ni-Cd column).



PATRIOT Series - NEMA 4X

NEMA 4X, VANDAL RESISTANT



PROJECT: _____
 FIXTURE TYPE: _____
 LOCATION: _____
 CONTACT/PHONE: _____

ELECTRICAL

BATTERY: The PATRIOT UNIT is designed with a maintenance free, sealed valve regulated lead acid battery that provides a minimum emergency duration of 90 minutes. Recharge time of the battery is forty- eight [48] hours. An optional Nickel-Cadmium battery is available. The battery operating temperature without the internal heater/thermostat option is 40°C maximum and 10°C minimum; with the internal heater (IH) option the minimum battery operating temperature is -20°C.

CIRCUIT: The PATRIOT UNIT utilizes a high-efficiency two stage charger providing precise float voltage control with low voltage disconnect protection. All components used in the circuitry are temperature compensated. The charger also has brownout and short circuit protection. Charger status is easily determined via a dual diagnostic LED display which indicates AC/ON and High Charge. A magnetic test switch allows maintenance personnel to quickly determine the operational status of the unit and lamp load.

MECHANICAL

The PATRIOT UNIT is constructed from a durable, fully gasketed diecast aluminum housing and polycarbonate lens. Universal mounting pattern and key hole slots are cast into the mounting backplate. Stainless steel mounting straps are supplied for surface mounting. Lamp loads are connected to the emergency power supply with sturdy terminal connectors. These connectors allow for a large gauge of wire to be used, increasing the flexibility or installation. The PATRIOT UNIT is supplied standard in a durable gray powder coat, baked finish. Other colors are available, including color matching, please specify. UL924 Certified.

EXTREME WEATHER







The PATRIOT UNIT has been designed to perform in applications where the environment would punish any standard unit. The entire internal cavity is protected from moisture ingress by an extremely resilient gasket. The gasketing always holds its original form and has “memory retention” so that it effectively and consistently protects the PATRIOT UNIT from moisture.

SANITATION LISTED

The PATRIOT UNIT is sanitation approved. The Intertek verified splash zone listing is equivalent to the NSF Standard 2, meeting the rigorous sanitation, electrical safety and performance standards of food service environments.

SELF-DIAGNOSTICS

The Mule auto-test automatically initiates a five minute discharge/ diagnostic test every month and two 90-minute discharge/diagnostic tests every 6 months. Twenty-four hours following the first 6 month test, the unit retests again to ensure that the charger has completely recharged the battery. The lamps and connected remote load will come on during these tests. The tests exercise the battery to optimize its capacity and analyse the unit’s emergency operation performance. Any malfunction of the transfer circuit, batteries or emergency lamps will cause the multi-colour DIAGNOSTIC LED on the unit to indicate the problem. The DIAGNOSTIC indications will remain latched (stay on) in the system until corrected or reset.

-  Steady Green : Normal Operation
-  Flashing Green : AC Interruption in Last 48 Hours
-  Steady Yellow : Lamp Circuit Malfunction
-  Flashing Yellow : Auto-test or Manual Test in Progress
-  Steady Red : Battery Failed Testing
-  Flashing Red : Battery Disconnected or Charger Malfunction

LAMP SELECTION

	6V	12V
MR16	-	20W
MR16 LED	5, 7W	2W, 5W, 7W

MODEL RATING GUIDE

Model	Voltage	Wattage			
		90min	120min	180min	240min
PTR-6-18	6	18	13	9	6
PTR-6-22-NC	6	22	16	11	8
PTR-6-36	6	36	27	18	13
PTR-6-42-NC	6	42	31	21	15
PTR-6-54	6	54	41	27	20
PTR-6-60	6	60	45	30	22
PTR-12-36	12	36	27	18	13
PTR-12-42-NC	12	42	31	21	15
PTR-12-60	12	60	45	30	22

NOTE 1: Not available with all options.

WARRANTY

The PATRIOT UNIT comes with a 3-year factory warranty. Deliberate damage, misuse, improper installation effectively cancel the warranty.