

INSTALLATION INSTRUCTIONS FOR LED EMERGENCY LIGHT

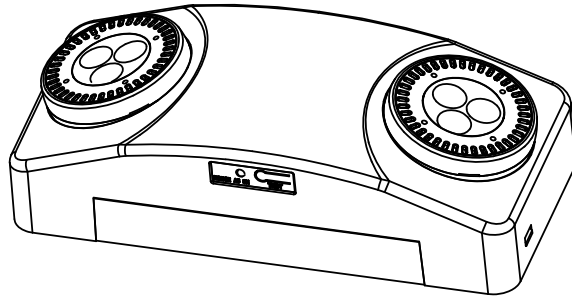

IMPORTANT SAFEGUARDS READ AND FOLLOW ALL SAFETY INSTRUCTIONS

When using electrical, basic safety precautions should always be followed including the following.

1. Disconnect power at fuse or circuit breaker before installing or servicing.
2. Do not use outdoors.
3. Do not mount in hazardous locations, or near gas or electric heaters.
4. Do not let power cords touch hot surface.
5. Equipment should be mounted in locations and at heights where it will not be subjected to tampering by unauthorized personnel.
6. The use of accessory equipment not recommend by the manufacturer may cause an unsafe condition.
7. Do not use this equipment for other than intended use.
8. All servicing should be performed by a qualified personnel only.
9. After finish installation, permit charge battery 24hours before full duration test.

SAVE THESE INSTRUCTIONS

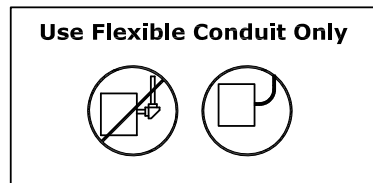

MAINTENANCE

None required. Replace the batteries as needed according to ambient conditions. However, we recommend that the equipment be tested regularly in accordance with local codes.

OPERATION

1. Press the test button. The LED heads will turn on and the LED indicator will turn off. Release the test switch, LED indicator will turn on and the LED heads will turn off.
2. After battery full charged, LED indicator will blinking at short time, this is normal phenomenon.

TROUBLE SHOOTING GUIDE

If LED heads or LED indicator does not illuminate, check the following:

1. Check AC supply - verify that unit has 24 hours AC supply.
2. Unit is shorted or battery is not connected.
3. Battery discharge. Permit unit to charge for 24 hours then re-test.
4. If above trouble shooting hints do not solve your problem, contact factory for assistance.

Mounting Instructions

Wall Mount-Back Power Feed (see Fig 2)

1. Use flat blade screwdriver insert the two slots and pry off then remove front cover from back plate (see Fig 1).
2. Remove appropriate knockout in back plate and mount back plate to J-box.
3. Knockout in center of back plate and feed wires through the hole.
4. Securely backplate to J-box.
5. Connect the fixture wires to the power supply wires using the wire nuts provided. Connect the white wire to neutral, connect the black wire to the hot lead. Cap the unused lead. Press the wires into the J-box (Refer to Wiring diagram below).
6. Connect remote wires if this item with remote capability. Refer to below instruction for remote wires.
7. Plug battery male connector into battery female connector on PCBA.(see Fig 2).
8. Snap the front cover on the back plate.
9. Restore power and press test button. LED heads will turn on.
10. Adjust the lamp heads direction as per needs.

Open fixture

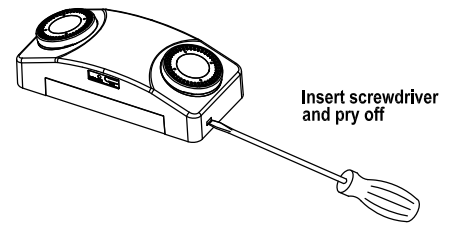

Fig 1

Wall mount-Back Power Feed

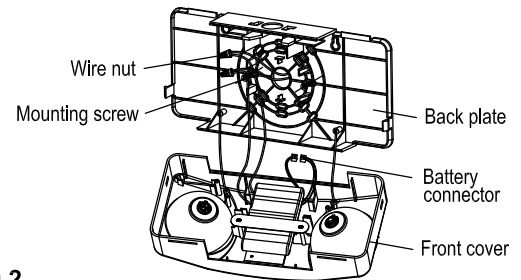

Fig 2

Wall Mount (Top Power Feed) (see Fig 3)

1. Open front cover and remove top knockout on the top flange of fixture.
2. Secure conduit (or surface raceway) to knockout and feed wires.
3. Remove appropriate knockout on back plate and mount to wall.
4. Refer to above 5 - 10 steps in Wall Mount-Back Power Feed.

Wall mount-Top Power Feed

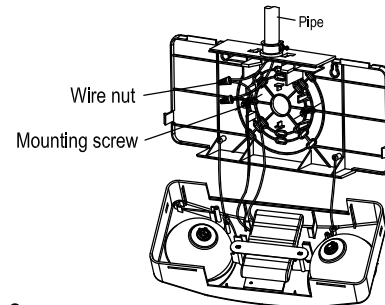

Fig 3

Ceiling Mount (see Fig 4)

Refer to above **Wall mount-Back Power Feed** instruction. Here is some differences :
 Mount back plate on the ceiling surface instead of wall surface.
 Feed building AC supply wire through back plate then connect to fixture power supply wires using wire nuts provided.

Connecting Remote head (option)

Connect extended remote head wires to remote wires using wire nut. yellow is positive(+), purple is negative(-). 9V 5.4W max. remote capability for this product.

Wiring Diagram

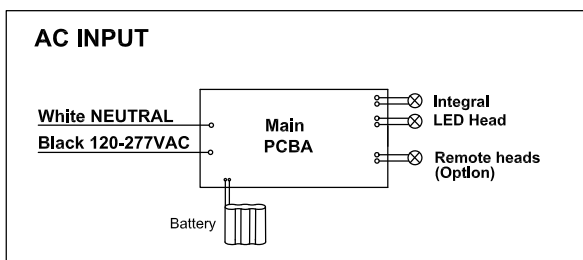

Ceiling mount-Top Power Feed

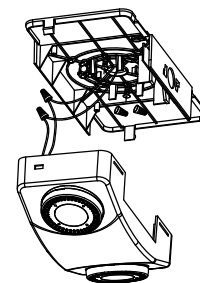

Fig 4

Mounting height

EXL-1960
EXL-1960HO

Max. mounting height 35ft
Max. mounting height 50ft