

INSTALLATION INSTRUCTIONS FOR LED EMERGENCY LIGHT

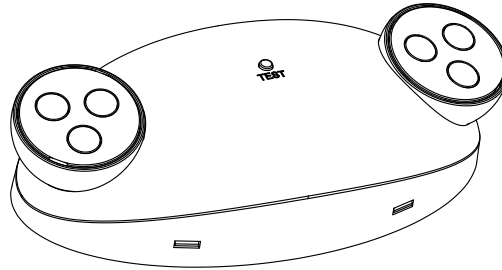

IMPORTANT SAFEGUARDS

READ AND FOLLOW ALL SAFETY INSTRUCTIONS

When using electrical, basic safety precautions should always be followed including the following.

1. Disconnect power at fuse or circuit breaker before installing or servicing.
2. Do not use outdoors.
3. Do not mount in hazardous locations, or near gas or electric heaters.
4. Do not let power cords touch hot surface.
5. Equipment should be mounted in locations and at heights where it will not be subjected to tampering by unauthorized personnel.
6. Do not use this equipment for other than intended use.
7. All servicing should be performed by a qualified personnel only.
8. After installation is finished, Please charge battery 24hours

SAVE THESE INSTRUCTIONS

Use Flexible Conduit Only

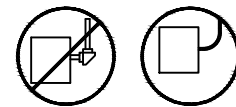

MAINTENANCE

Battery have to recharge if product keep in stock over 12 months, detail manual refer "BATTERY STOCK AND RECHARGE GUIDELINE". We recommend that the equipment is tested regularly in accordance with local codes. Replace the batteries as needed if discharge time do not achieve 90 minutes.

OPERATION

Press the test button. The LED heads will turn on and the LED indicator light will turn off.
Release the test switch, So that the LED indicator will turn on and the LED heads will turn off.

TROUBLE SHOOTING GUIDE

If LED heads or LED indicator does not illuminate, check the following:

1. Check AC supply - verify that unit has 24 hours AC supply.
2. Battery connection.
3. Discharge the Battery and then charge the battery for 24 hours and retest.
4. If above trouble shooting hints do not solve the problem, contact factory for assistance.

Mounting Instructions

Wall Mount - Back Power Feed (see Fig 2)

1. Use flat blade screwdriver pry off frontcover from back plate (see Fig 1).
2. Remove appropriate knockout in back plate.
3. Feed wires through the hole.
4. Secure backplate to J-box.
5. Connect the fixture wires to the power supply wires using the wire nuts provided. Connect the White wire to neutral, connect the black wire to hot, press the excess wires into the J-box (Refer to Wiring diagram below).
6. Connect battery connector.(see Fig 2).
7. Snap the front cover onto the back plate.
8. Restore power and press test button. LED heads will turn on.
9. Adjust the lamp head and lens direction as per needs

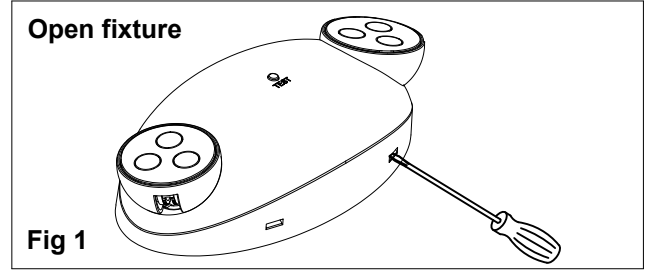

Fig 1

Wall mount-Back Power Feed

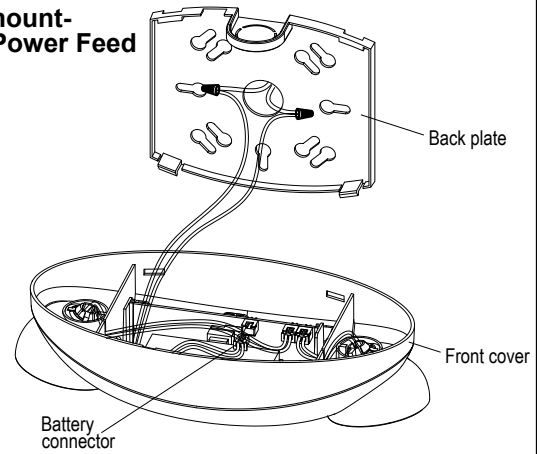

Fig 2

Ceiling Mount (see Fig 3)

Refer to above **Wall mount-Back Power Feed** instruction.

Here is some differences :

- Mount back plate on the ceiling surface instead of wall surface.
- Feed building AC supply wire through back plate then connect to fixture power supply wires using wire nuts provided.

Wall Mount - Top Power Feed (see Fig 4)

1. Open front cover and remove top knockout on the top flange of fixture.
2. Secure conduit (or surface raceway) to knockout and feed wires.
3. Remove keyhole knockout on back plate and mount to wall.
4. Refer to above 5 - 9 steps in Wall Mount-Back Power Feed.

Ceiling mount-Top Power Feed

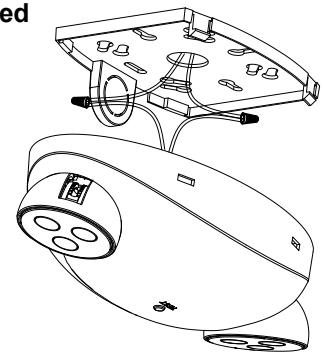
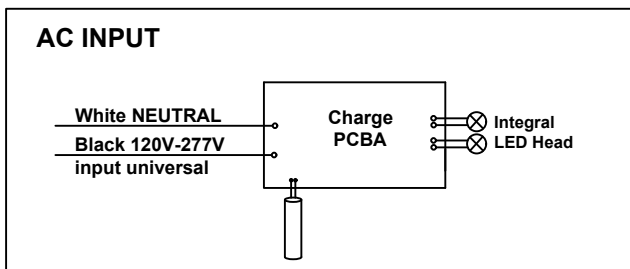

Fig 3

Max. Mounting Height

Ceilling mounting		Wall mounting	
M5U-LFP-CT	22 ft	M5U-LFP-CT	21 ft

Wiring Diagram



Wall mount-Top Power Feed

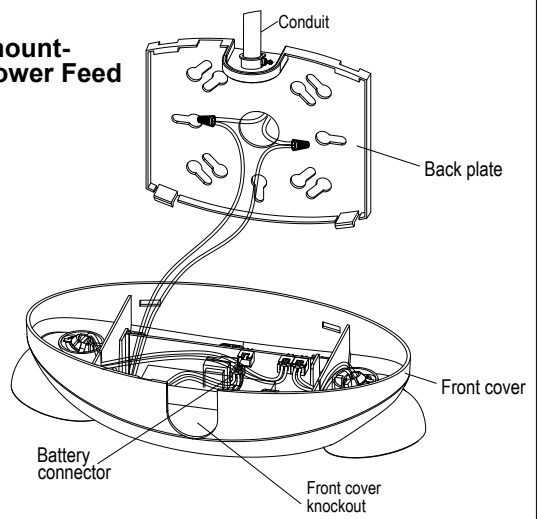

Fig 4

Use Flexible Conduit Only

